



INSTALLATION MANUAL

BAG-TTACP0523

For 05-23 Toyota Tacoma (4WD Only); 05-23 Tacoma Prerunner (2WD Only)



Engineered to Ride, Built to Last[®]



WARNING



DO NOT LIFT YOUR VEHICLE FROM FRAME IF YOU HAVE AIR SPRINGS INSTALLED & INFLATED

If it is necessary to lift the vehicle by the frame, first release the air pressure from the air springs. This will allow the air springs to extend to their maximum length without being damaged. The uninflated air springs are capable of supporting the weight of the axle when the vehicle is lifted by the frame. After vehicle servicing is complete, lower the vehicle to the ground and reinflate the air load leveling springs to the desired pressure.

**BEFORE INSTALLATION, CHECK FOR ANY MISSING PARTS.
PLEASE REFER TO THE “PARTS” PAGE.**

TABLE OF CONTENTS & OVERVIEW

IMPORTANT	4
PARTS	5
INSTALLATION	6
FINISHING THE INSTALLATION	17
SAFETY TIPS	18
BASIC OPERATION	19
TROUBLESHOOTING GUIDE	22

IMPORTANT

Please do not hurt yourself, your kit, or your vehicle. Please, take a moment to read this important information. This kit is to be used on a **pickup truck only** and **does not increase your vehicle's maximum load**.

SAFE INSTALLATION

Please take all safety precautions during installation. A hydraulic jack can fail, and if that happens, you can be seriously hurt, or worse, if you are relying on it to hold up the vehicle. If you use a hydraulic jack, secure jack stands in the appropriate locations and chock any tires still touching the ground.

Wear safety glasses or goggles. Your eyes may be lower than some parts and pieces, and you don't want to lose an eye.

Remove the possibility of any electrical issues by disconnecting the negative battery cable.

KIT CLEARANCE

There must be a minimum of 1/2" clearance around all installed components when the Air Springs are inflated and under a load. The Air Springs must flex and expand during operation, so the clearance keeps the kit from rubbing against parts of the vehicle.

VEHICLE GVWR

NEVER exceed the maximum load recommended by the vehicle manufacturer (GVWR). The GVWR can be found in your vehicle's owner's manual or on the data plate on the driver's side door. Consult your local dealership for additional GVWR specifications.

INFLATING THE AIR SPRINGS

When inflating Air Springs, add air pressure in small quantities, checking air pressure frequently.

The Air Springs have much less air volume than a tire, so they inflate much more quickly.

PRESSURE TO LOAD

The Air Springs will support approximately 50 lbs. of load for each PSI of inflation pressure (per pair).

For example, 50 PSI of inflation pressure will support a load of 2500 lbs. per pair of Air Springs.

APPROPRIATE AIR PRESSURE

For best ride, use only enough air pressure in the Air Springs to level the vehicle when viewed from the side (front to rear). This will vary depending on the load, location of the load, condition of the existing suspension, and personal preference.

OPTIONAL T-FITTING

This kit includes Inflation Valves and Air Line Tube for each Air Spring, allowing you to compensate for unbalanced loads. If you prefer a single Inflation Valve system to provide equal pressure to both Air Springs, your dealer can supply the optional "T" fitting.

ONCE INSTALLED SUCCESSFULLY, FOLLOW THESE PRESSURE REQUIREMENTS FOR THE AIR SPRINGS:

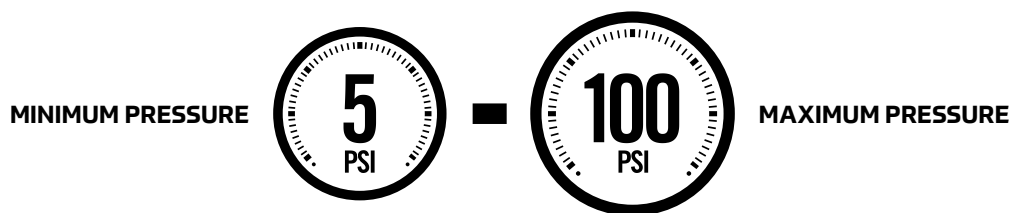

PARTS

Compare the parts below to your kit. Assure you have all pieces, and organize them for an easier installation.

Air Spring	x2	3/8" - 16 X 1" Hex Bolt	x8	5/16" Flat Washer	x4
Upper Bracket	x2	5/16" - 18 X 1" Hex Bolt	x4	3/4" - 16 X 1 3/4" Hex Bolt	x2
Under Frame Upper Bracket	x2	3/4" Flat Washer	x4	5/16" - 18 Flange Lock Nut	x4
Lower Bracket	x2	3/4" - 16 Hex Lock Nut	x2	Air Fitting	x2
Bracket Clamp	x2	3/8" - 16 X 3/4" Hex Bolt	x2	3/8" - 16 X 3 1/2" Carriage Bolt	x8
Leaf Stack Strap Bracket	x4	5/8" - 18 Hex Lock Nut	x2	Red Nylon Tie	x7
Heat Shield	x1	3/8" - 16 Flange Lock Nut	x16	Thermal Sleeve	x2
Air Line Tube (18 Feet)	x1	3/4" Lock Washer	x2	Inflation Valve & Valve Cap Assembly	x2

INSTALLATION

1. REMOVE EXISTING JOUNCE BUMPER



WARNING:

Start the installation on the left side of the vehicle when facing forward.

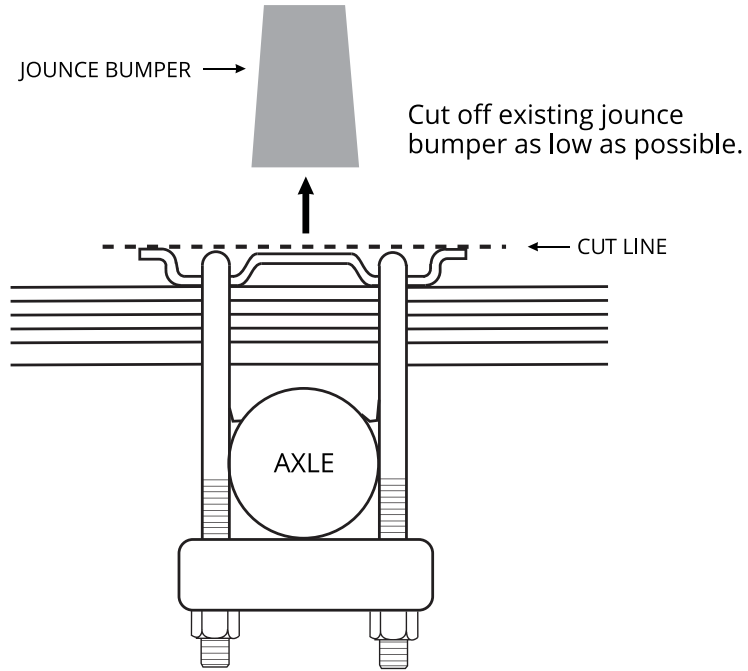

2. CREATE AIR SPRING ASSEMBLY

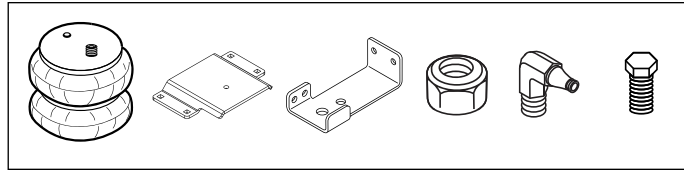

1 Install the air spring to the lower bracket, as shown.

2 Place the upper bracket on top of the air spring.

3 Make sure the alignment pin is fully seated in the alignment pin hole in the upper bracket.

4 Fasten the upper bracket to the air spring.

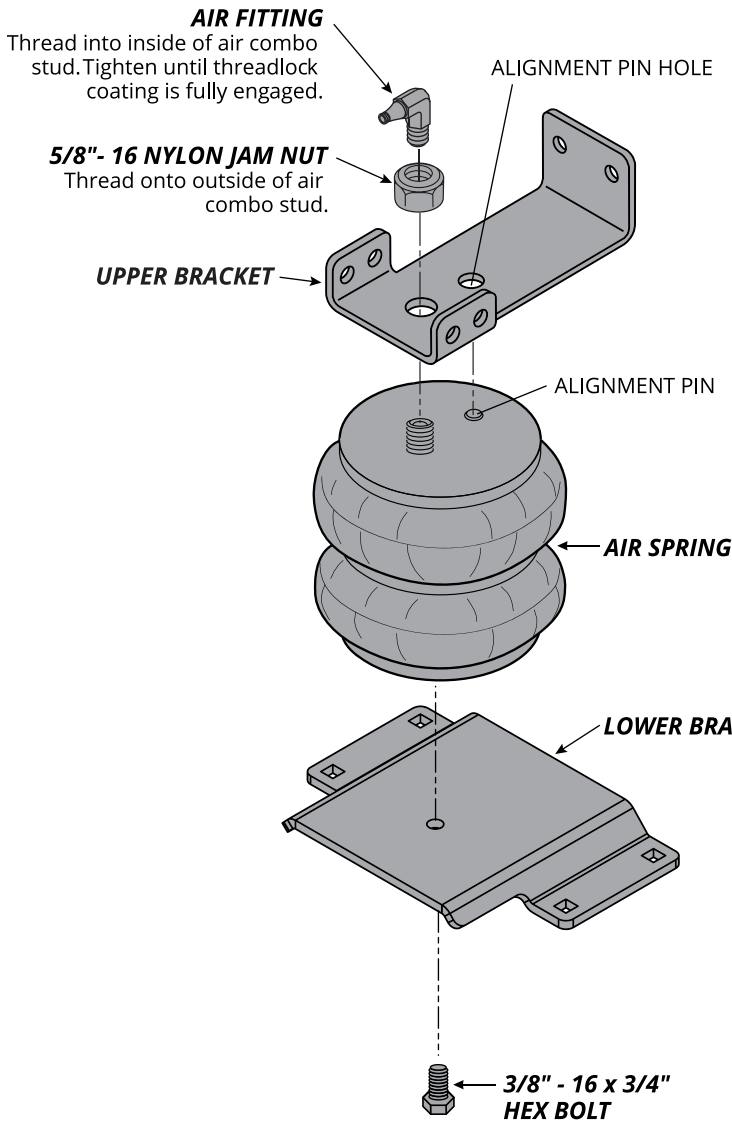

WARNING:

Installing the right side? Remember to install the heat shield in step 7 first!



WARNING:

Alignment pin on air spring must be installed to fully seat into the alignment hole in the upper bracket. Failure to do so will cause it to be pushed into the bead plate, creating an air leak, and resulting in an air spring failure that is **not warrantable**. The alignment pin cannot hold 2,500 lbs! It is used for alignment only!



WARNING:

Do not fully tighten the bolt at this stage. Torque to spec in step 6.

3. INSTALL THE UPPER BRACKET

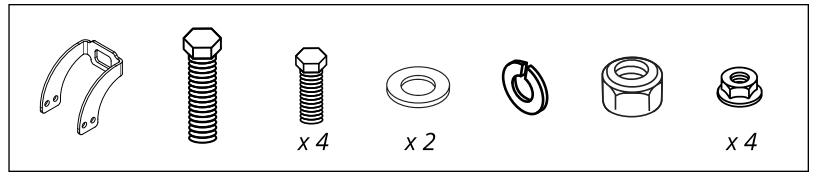

1 Dry fit the air spring assembly over the leaf spring stacks and make alignment marks, as shown.

2 Align marks and fully tighten the 3/8"-16 x 3/4" hex nut on the bottom of the lower bracket.

3 Attach the upper frame bracket to the upper bracket and vehicle frame, as shown.

4 Install all 3/4" hardware to fasten the upper frame bracket to the vehicle frame.

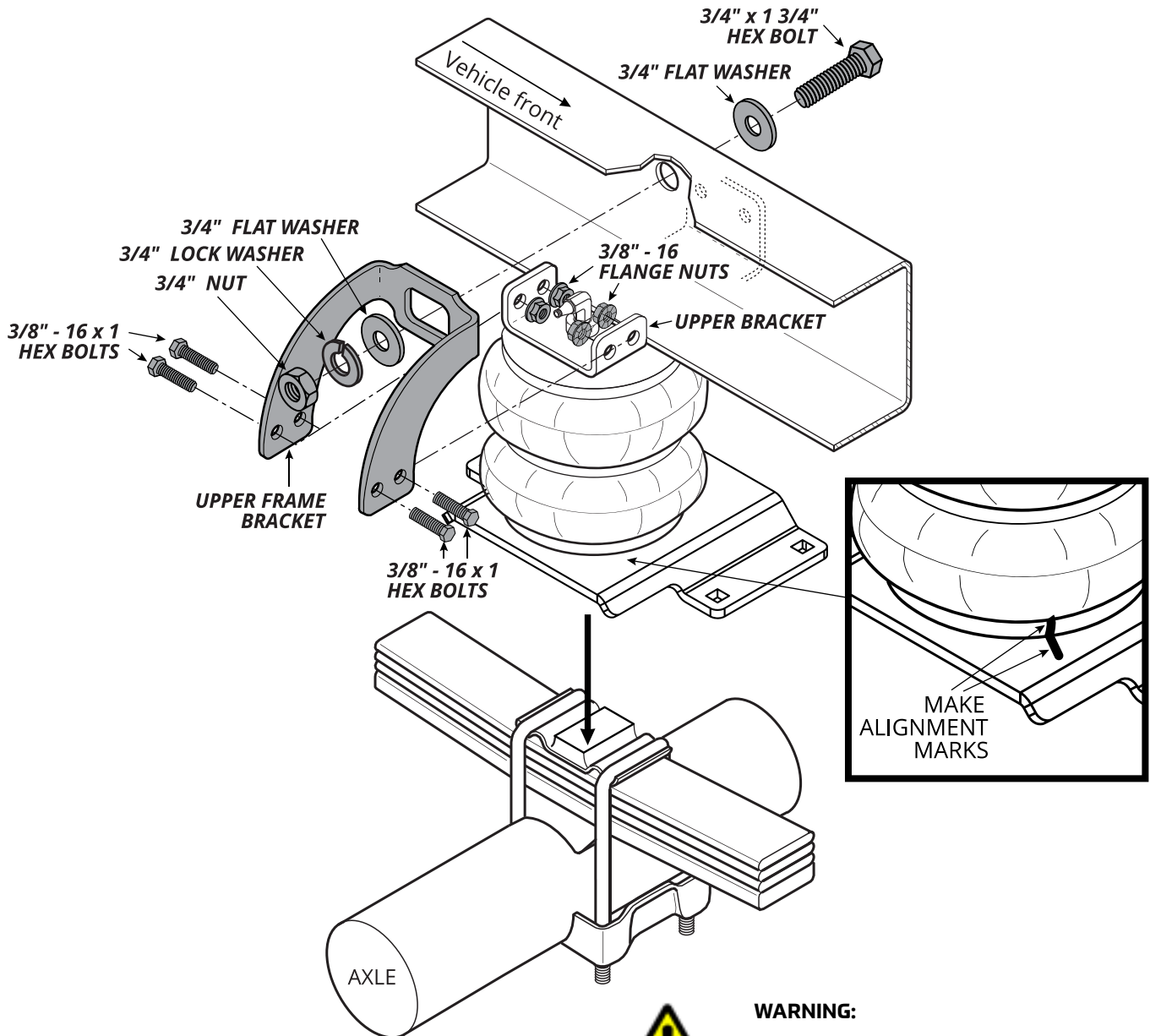

WARNING:

Did you fully tighten the hex nut on the bottom of the lower bracket?

4. INSTALL BRACKET CLAMP

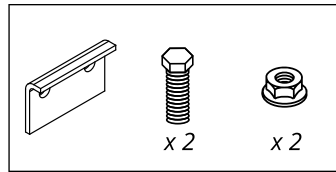

1 Slide the bracket clamp into the jounce bumper brace on the vehicle.

2 Fasten the bracket clamp to the upper bracket, as shown. Assure that the vehicle jounce bumper brace is sandwiched between the upper bracket and bracket clamp.

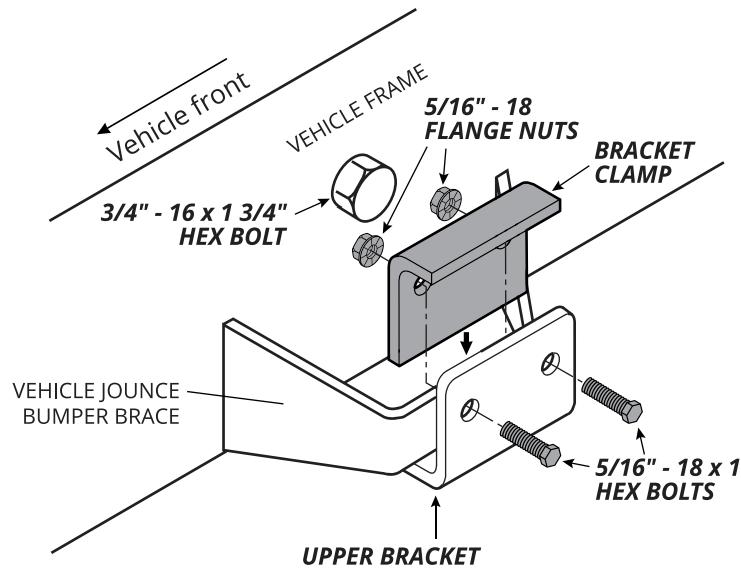

5. INSTALL LEAF STACK BRACKET STRAPS

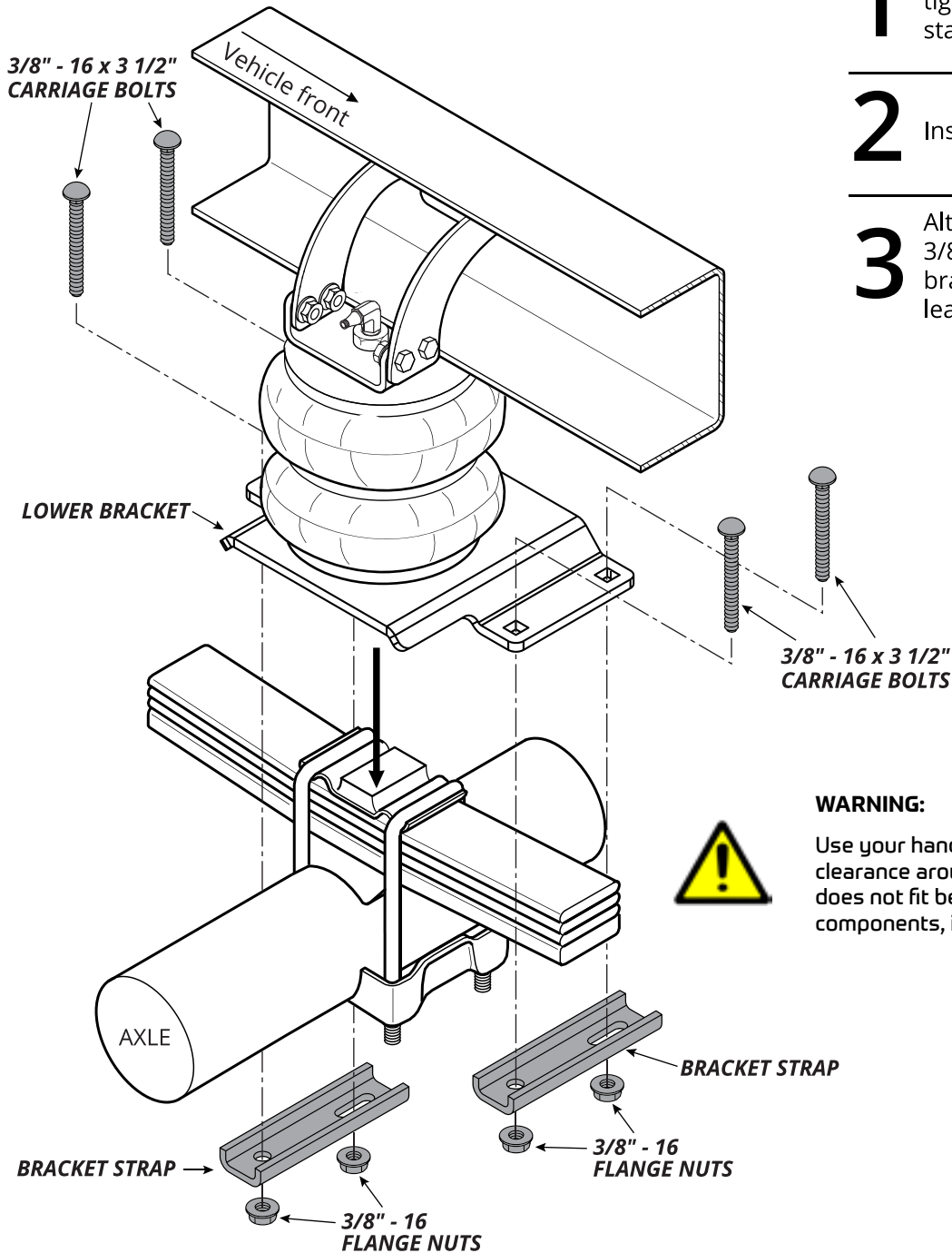
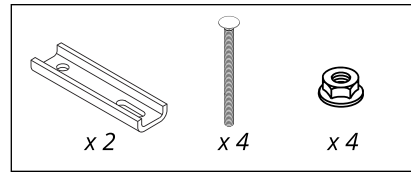

1 Assure that lower bracket is tight against the leaf spring stack on the vehicle.

2 Install fasteners, as shown.

3 Alternate tightening of the 3/8"-16 flange nuts to draw bracket straps evenly to the leaf springs.

WARNING:



Use your hand to check for the proper clearance around the air spring. If your hand does not fit between the air spring and other components, it will rub!

6. INSTALL HEAT SHIELD

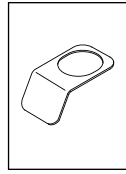

WARNING:

Right side installation must include heat shield!

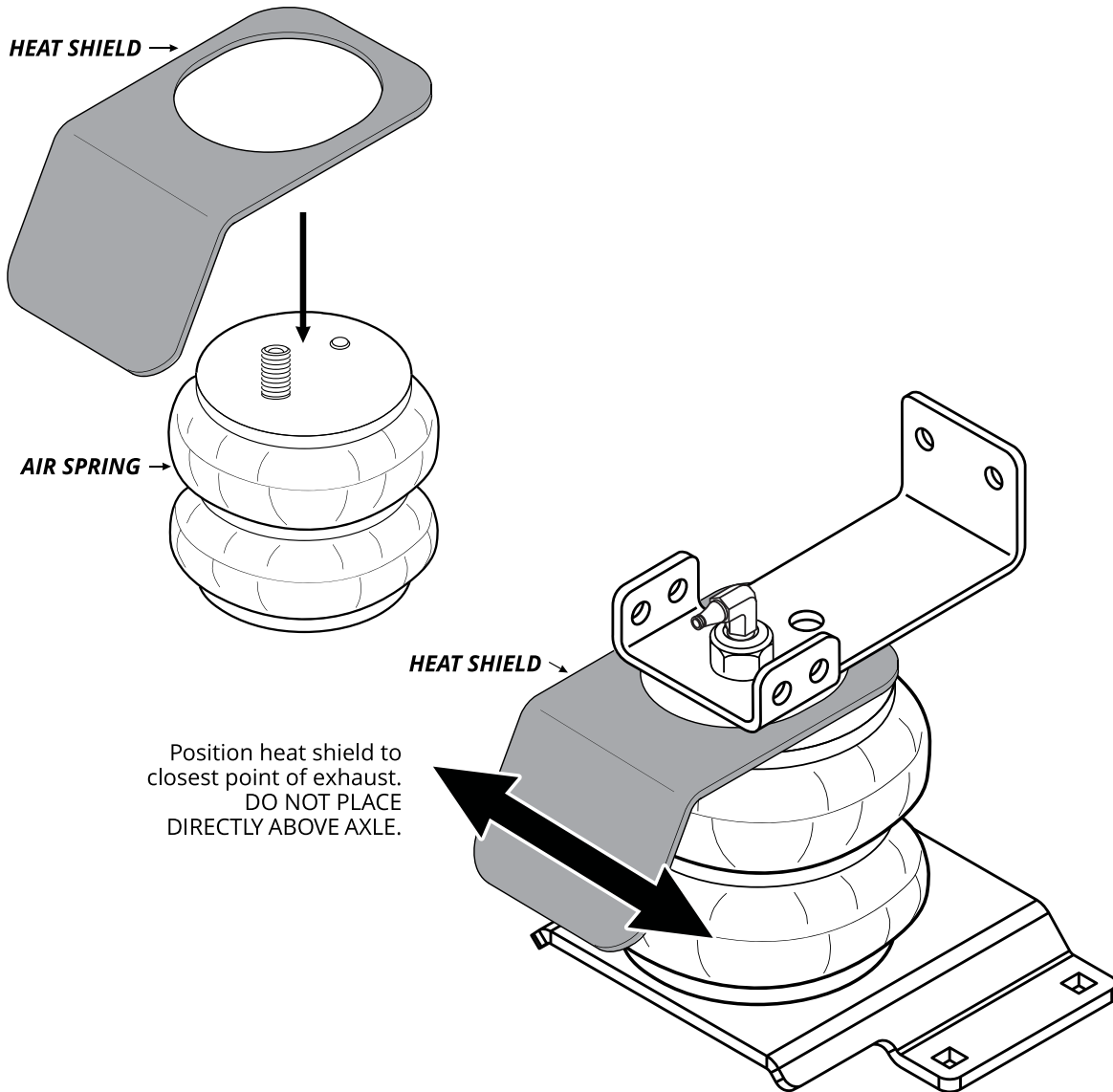

7. INSTALL INFLATION VALVES

1. Select a protected location to install the inflation valves, such as the bumper or the body of the vehicle.
Drill two 5/16" holes for inflation valve install locations.

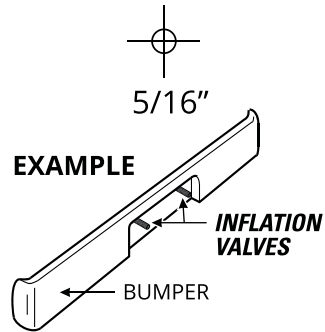
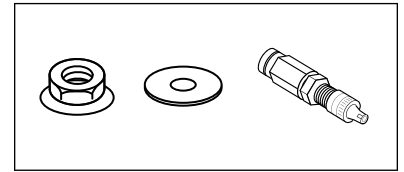

2. Install inflation valve assembly as shown.

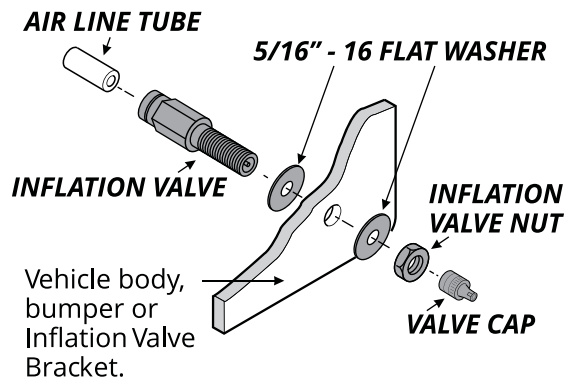

8. CUT THE AIR LINE TUBE INTO TWO EQUAL LENGTHS

1. Match Air Line Tube ends.
2. Find center of Air Line Tube, make a square cut with tube cutter or sharp utility knife.

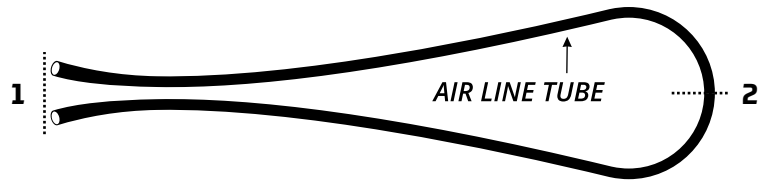

DO

Make sure the cut is as square as possible. Use a tube cutter or sharp utility knife.

DON'T

Fold or kink the Air Line Tube. Cut the Air Line Tube at an angle. Use pliers, scissors, saws, or side cutters.

PROPER & IMPROPER CUTS IN THE AIR LINE TUBE

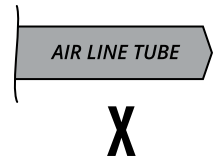
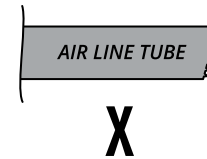
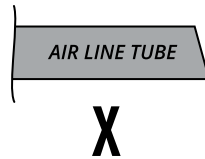
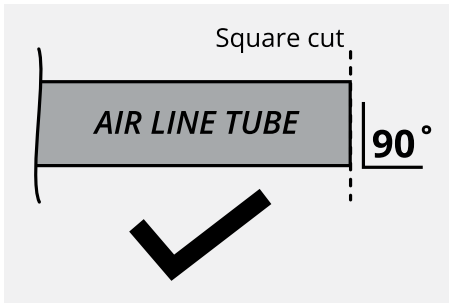

9. INSTALLING AIR LINE TUBE INTO AIR FITTINGS & INFLATION VALVE

1. Insert end of Air Line Tube into Air Fitting.
2. Push Air Line Tube into Air Fitting as far as possible.
3. Gently pull on the Air Line Tube to check for a secure fit.
4. To remove, push down collar and gently pull Air Line Tube away.

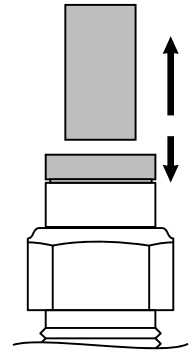
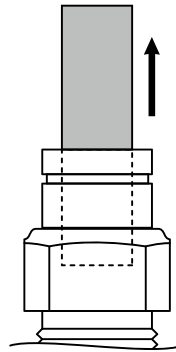
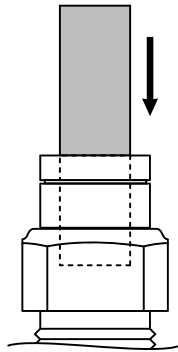
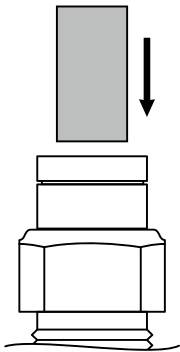

Removal Tip: Use a 1/4", 5/16", or 6mm open-ended wrench to push the collar down.

10. ROUTE AND SECURE AIR LINE TUBES

Air Line Tube routes will vary, depending on your truck, and requires you to choose the best path from the Air Springs to the Inflation Valves. Use the instructions below to help you choose.

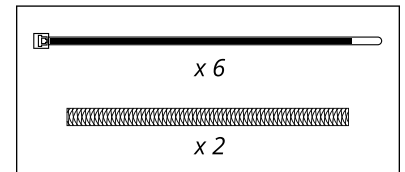

DO

Select routes protected from heat, debris, and sharp edges. Use Thermal Shields near heat sources. Use Nylon Ties to secure the Air Line Tube.

DON'T

Bend or sharply curve Air Line Tubes. Leave Air Line Tube exposed to sharp edges. Use unnecessary lengths of Air Line Tube. Route Air Line Tube near moving parts. Let Air Line tube hang unsecured from vehicle. Scar Air Line Tube while routing.

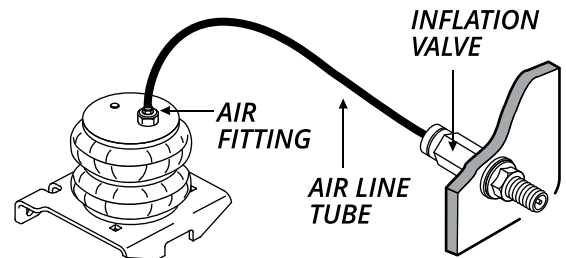
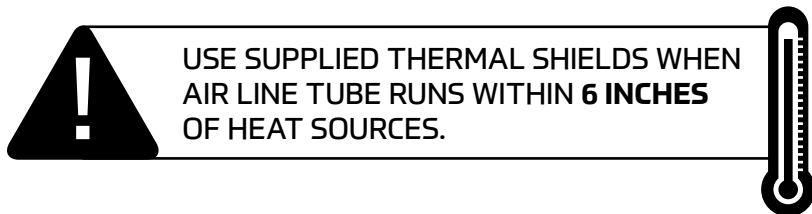
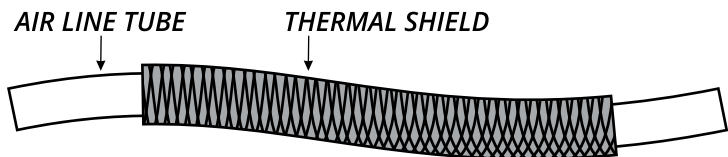

CHECKING THE AIR SYSTEM

1. Place an air chuck onto the Inflation Valve and fill the system to **70 PSI**.

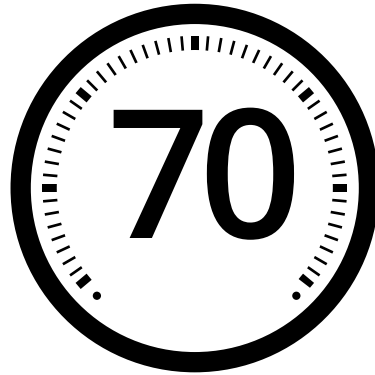
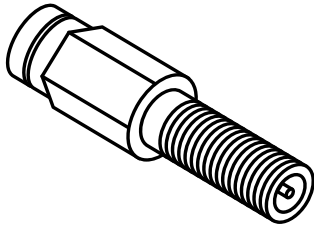

AIR SPRINGS INFLATE QUICKLY.
CHECK AIR PRESSURE WHILE INFLATING.

2. Spray fittings with soap and water mixture.

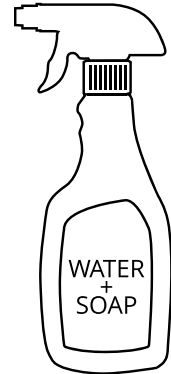

3. Observe bubbles.

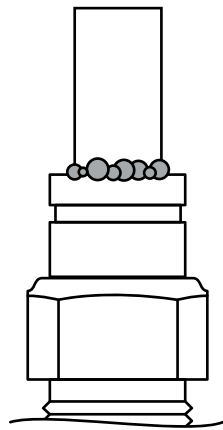

SMALL SOAP BUBBLES
THAT DO NOT EXPAND

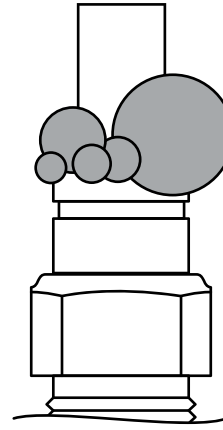

SOAP BUBBLES
THAT EXPAND



NO LEAKS?

Congratulations! Continue to the “Finishing the Installation” section. Review the Operating Instructions.

LEAKS?

Continue to the “Fixing an Air Leak” section to fix the leak.

FIXING AN AIR LEAK

1. Press the air valve on end of Inflation Valve to release all air pressure.

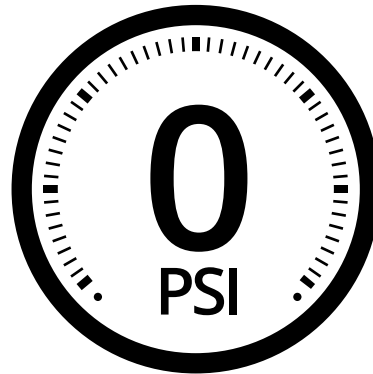
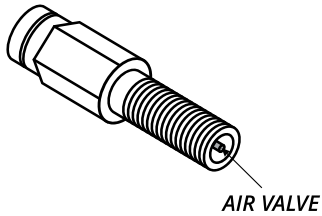

EXHAUST ALL AIR FROM THE SYSTEM PRIOR TO RELEASING AIR LINE TUBES FROM AIR FITTINGS.

LEAK AT AIR LINE TUBE & AIR FITTING

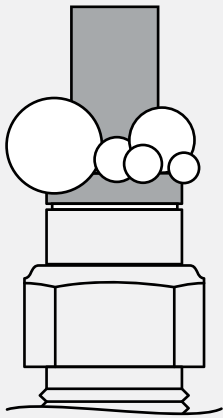

Release air line tube as seen in the “Installing Air Line Tube” section. Review proper cuts and procedures in the “Cut the Air Line Tube” section. When complete, followed the steps outlined in the “Installing Air Line Tube” section, followed by the “Checking the Air System” section.

LEAK AT BASE OF AIR FITTING ON AIR SPRING

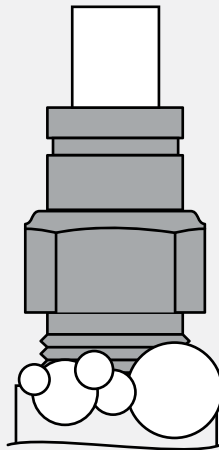

Tighten Air Fitting one turn or until leak stops.

LEAK OUT OF THE VALVE CORE ON INFLATION VALVE

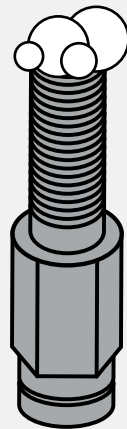

Tighten valve core with valve core wrench on Inflation Valve Cap.

FINISHING THE INSTALLATION

SAFELY RETURN VEHICLE TO OPERATIVE STATE

If you removed any wheels during installation, install the wheels and torque the lug nuts to the manufacturer's specifications.

Safely remove any jack stands and wheel chocks used during installation.

Re-attach the negative battery cable.

DOUBLE-CHECK AIR SPRING CLEARANCE

Check the Air Springs once again for the proper 1/2" minimum clearance. Perform clearance check again when vehicle is under load.

VEHICLE GVWR

NEVER exceed the maximum load recommended by the vehicle manufacturer (GVWR). The GVWR can be found in your vehicle's owner's manual or on the data plate on the driver's side door. Consult your local dealership for additional GVWR specifications.

READ & UNDERSTAND THE OPERATING INSTRUCTIONS

The system can improve handling and comfort. Take the time to learn how to properly use and maintain your investment by reading the Operating Instructions.



USE YOUR HAND TO CHECK FOR THE PROPER CLEARANCE AROUND THE AIR SPRING. IF YOUR HAND DOES NOT FIT BETWEEN THE AIR SPRING AND OTHER COMPONENTS, IT WILL RUB!

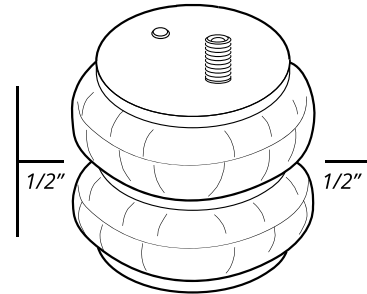

IMPORTANT

A MINIMUM OF 5 PSI MUST BE MAINTAINED IN THE AIR SPRINGS AT ALL TIMES

Too much air pressure in the Air Springs will result in a firmer ride, while too little air pressure will allow the Air Springs to bottom out over rough conditions, and will not provide the improvement in handling that is possible.

MINIMUM PRESSURE



MAXIMUM PRESSURE (LOADED)

SAFETY TIPS

NEVER EXCEED THE MANUFACTURER'S RECOMMENDED GROSS VEHICLE WEIGHT RATING (GVWR)

As with your vehicle's tires, an air helper spring is a pneumatic device that supports a portion of the vehicle's weight.

The air helper spring may fail as a result of punctures, impact damage, improper inflation, improper installation, or improper usage. To reduce the risk of failure, we strongly recommend the following:

Never overload your vehicle. The manufacturer's gross vehicle weight rating (GVWR) is stated on the specification plate on the chassis. You should weigh your vehicle on a truck scale when it is fully loaded and in a level condition to determine if you are exceeding the manufacturer's recommended GVWR.

Inspect the inflated air springs to verify that they do not contact any component of the vehicle under normal suspension operation. The air helper spring must flex and expand during normal operation. There must be at least 1/2" of clearance between the inflated air spring and any other component of the vehicle under normal suspension operation.

Inspect the air line tubing and the air spring to verify that they have not been too close to the exhaust system. If the distance between any portion of the air spring or air line tubing and the exhaust system is less than 6", a heat shield should be used.

Never inflate the air helper springs beyond the maximum pressure indicated in the installation manual.

Never attempt to remove any component of the air spring assembly when the air springs are inflated.

If an air helper spring has failed while you are on the road, operate your vehicle at reduced speeds. High speed over rough roads will result in severe bottoming of the air spring and may damage other vehicle components.

Never attempt to drive the vehicle in an unlevelled condition. Failure to level a heavily loaded vehicle may result in excessive body roll and possible damage or injury.

Never cut, weld, or modify the air helper springs or brackets.

Do not use aerosol tire repair products in the air helper springs or a tire patch of any kind on the air helper spring. If there is a hole in the air spring it must be replaced.

GENERAL INFORMATION

The helper springs are heavy duty, quality air springs designed to supplement your vehicle's existing suspension system. These durable air springs allow you to maximize your vehicle's load carrying capacity through the use of air pressure. Proper installation, use, and operation will provide the maximum service life and performance your air spring kit is capable of delivering. These instructions will help you obtain the maximum benefits available from your air spring kit.

AIR HELPER SPRINGS

The air helper springs are installed between the frame and the suspension of trucks, vans, and motorhomes.

The air helper springs are capable of supporting loads up to 5000 lbs per pair.*

***Do not exceed the vehicle's recommended gross vehicle weight rating (GVWR)**

BASIC OPERATION

As your vehicle is loaded, the stock suspension is compressed under the weight of the load. Your vehicle's stock suspension system has been designed so that it will provide optimum performance and handling with a specific load on the vehicle. When your vehicle is loaded, its performance, handling characteristics, and ride quality may be compromised. As the stock suspension is compressed, the ride may become "mushy", and you may encounter sway and handling problems. As weight is added to the vehicle, the air helper springs become an active part of the suspension system. As more air pressure is added to the air springs, they will support more weight. You will be able to compensate for a heavy load by adding air pressure to the air springs, thereby reducing sway and handling problems associated with a heavily loaded vehicle.

TABLE "A"	
ALL TORQUE SPECIFICATIONS	
Using a torque wrench, torque the threaded fasteners to the following specifications:	
Fasteners used on studs and blind holes in air springs	15 – 20 ft lbs
Hex nuts installed on carriage bolts	10 – 15 ft lbs
Hex nuts installed on 3/8" hex bolts	28 – 32 ft lbs
Hex nuts and bolts used to secure brackets to frame	28 – 32 ft lbs
Hex nuts installed on U-bolts	15 – 20 ft lbs
Hex bolts securing tapered sleeve style air spring to lower bracket	10 – 12 ft lbs

PREVAILING-TORQUE LOCK NUTS

In order to assure trouble-free operation, your air spring kit includes a variety of self-locking threaded fasteners. Your kit may include prevailing-torque lock nuts. Prevailing-torque lock nuts may be more difficult to install, but will not come loose under normal suspension operation.

THREAD LOCKING COMPOUND

The hex bolts used to secure the air spring to the brackets may have a locking compound applied to the threads. Lock washers are not required when using a fastener with pre-applied thread locking compound. When installing fasteners with thread locking compound, follow the torque recommendations listed in table.

HELICAL LOCK WASHERS

Your air helper spring kit may include helical lock washers. In order to properly use the lock washer, tighten the nut/bolt fastener just enough to flatten the lock washer. Overtightening the fastener may damage the nut or bolt. When using helical lock washers, follow the torque recommendations listed in Table "A".

AIR FITTINGS

Your kit will include one of two types of push-to-connect air fittings: fittings with a thread locking compound preapplied to the threads or fittings with a Nylon collar in place of the thread locking compound.

The pre-applied thread sealant, thread the air fitting into the air spring and tighten the fitting securely to engage the pre-applied thread sealant.

The Nylon collar, thread the air fitting into the threaded hole on the air spring so that the Nylon collar makes contact with the top of the air spring and then tighten 1/2 turn. No thread sealant is required.

Both types of air fittings allow easy connection between the air fitting and the air line tubing. To install the air line in the fittings, cut the tubing as square as possible using a sharp utility knife or razor blade. Push the air line into the fitting as far as possible. If the tubing must be removed from the fitting, first release the air pressure from the air spring. Push the collar towards the body of the fitting and then pull the tubing out.

PRESSURE DIFFERENTIAL BETWEEN AIR SPRINGS

It is not uncommon to have different pressures between the air springs after the vehicle has been brought to a level condition. If the vehicle is within the manufacturer's recommended gross vehicle weight and you have not achieved a level condition after inflating the air springs to 100 psi, there may be a problem with your stock suspension. The leaf springs may have become fatigued over time or a leaf spring may be fractured. There may be an obstruction in the air system, not allowing the air pressure to reach the air helper springs.

AIR SPRING ALIGNMENT AND HEIGHT

Upon completion of the installation, the air springs should be inspected for proper alignment. Although the air helper springs can function with some misalignment, it is preferred that the air springs be mounted so that they are aligned with as little top to bottom offset as possible.

Check the distance between the upper bracket and lower bracket (design height). The dimensions shown on Page 5 are a guide to assist in determining the ideal operating height for your air helper springs.

INFLATING THE AIR SPRINGS

With the air helper springs installed on your vehicle and the vehicle sitting on a level surface, visually verify that the vehicle is in a level state. If the vehicle is not level (front-to-back or from side-to-side) it can be brought to a level position by inflating the air springs. Each air spring has a separate inflation valve. To level the vehicle from front-to-back, add air pressure to both air springs in equal amounts. To level the vehicle from side-to-side, add more air pressure to the air spring on the lower side of the vehicle. When inflating the air springs, add air pressure in small quantities, checking the pressure frequently. The air spring requires much less air volume than a tire, and therefore, will inflate and deflate quickly.



WARNING:

DO NOT EXCEED THE MAXIMUM PRESSURE AS INDICATED IN THE INSTALLATION MANUAL

LEVELING THE VEHICLE

Check the level of your vehicle visually. If it is not level, either from front to back or from side to side, level it by inflating your air springs. (If your vehicle is equipped with a cab control unit or automatic control system refer to the directions for that device.) There is one inflation valve for each air spring. To level from front to back, add air pressure to both air springs equally. For side to side, add air pressure to the air springs on the side of the vehicle that is low. When adding air pressure to the air springs, remember that they have a much smaller volume of air than a tire so they will inflate much quicker. Add air pressure in short bursts until the vehicle is level. (NEVER EXCEED 100psi IN EACH AIR SPRING.)

MAINTENANCE

It is considered normal for air helper springs to lose some air pressure over time. Normal pressure loss should not exceed 3 – 4 psi per week when the air springs are inflated to 50 psi. If the pressure loss is greater than 3 – 4 psi per week, there may be a leak in the system. Each time you check the pressure in the air springs, you will lose 1 – 3 psi. The air pressure should be checked at regular intervals.

It is recommended that the air pressure be checked according to the following guidelines:

At least monthly intervals during the continuous operation of the vehicle (see above)

When the vehicle is removed from long-term storage

If the air springs are used to assist in leveling an RV or camper on uneven ground, ensure that the vehicle is returned to a level ride height before departing.

The brackets used to secure the air helper spring to the vehicle should be inspected periodically for damage and for loose fasteners. Ensure that the air line tubing is clear of any sharp edges and routed away from the exhaust system. The brackets and air line tubing should be inspected every 6 months. Ensure that the threaded fasteners are torqued to the specifications listed under “Basic Operation”.

Accumulated sand, gravel, or other road debris on the air springs or brackets should be rinsed away with a garden hose each time the vehicle is washed.

If it is necessary to lift the vehicle by the frame, first release the air pressure from the air springs. This will allow the air springs to extend to their maximum length without being damaged. The uninflated air springs are capable of supporting the weight of the axle when the vehicle is lifted by the frame. After servicing of the vehicle is complete, lower the vehicle to the ground and reinflate the air helper springs to the desired pressure.

TROUBLESHOOTING GUIDE

AIR SPRING WILL NOT INFLATE

- Ensure that the air line tubing is inserted into the air fittings as far as possible. The tubing should go in the fitting 3/4 of an inch. You will feel some resistance when the tubing goes past the O-ring.
- Clear any dirt or debris from inside the inflation valves.
- Inspect the entire length of air line tubing to ensure that it is not kinked, damaged from exhaust heat, or cut due to contact with sharp edges.

AIR SPRING WILL NOT HOLD AIR

- Normal pressure loss is no more than 3 - 4 psi per week when the air spring is inflated to 50 psi.
- Using the inflation valve cap as a core tool, ensure that the valve stem core is installed securely.
- Apply a solution of soap and water to the air fittings, air line, and air springs to check for leaks. Tighten the air fitting or re-install the tubing in the air fitting to stop the leak. Rinse the soap and water solution from the system when complete.
- If a leak can not be detected with the soap and water solution, deflate the air springs and remove them from the vehicle. Re-install the tubing and inflation valve on the air spring and inflate the air spring to a maximum of 20 psi. Submerge the air spring in a bucket of water to check for leaks.

LOCATIONS OF AIR LEAKS

- Leaks occur most often at the threaded connection between the air fittings and the air springs. Tighten the fitting to engage the pre-applied orange thread sealant or until the nylon collar makes contact with the air spring, plus 1/2 turn, depending on which type of fitting is included in your kit. (See air fittings under “Basic Operation”)
- The end of the air line tubing must be cut square and clean to avoid burrs in the connection to the air fittings. The push-to-connect fittings require a square cut to properly seal. The tubing can be removed from the fitting by first releasing the air pressure from the air spring. Push the collar on the fitting toward the body of the fitting. While holding the collar in, pull out the tubing. Cut the tubing squarely and push the tubing into the fitting as far as possible.

THE VEHICLE IS NOT LEVEL

- Check for proper inflation of the air springs on each side of the vehicle.
- Check for obstructions in the air system or vehicle components that may be restricting suspension travel.

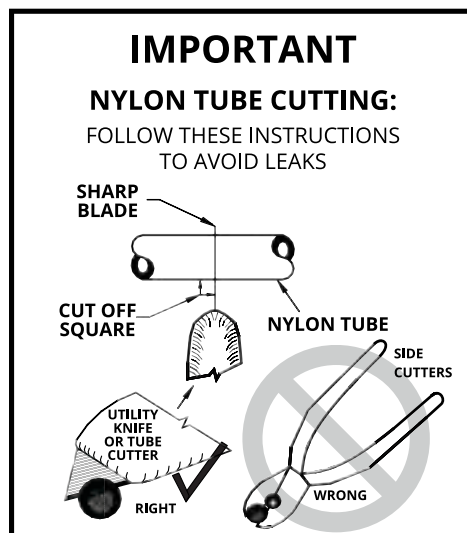

Arnott™

Suspension Products

Arnott US Business Office:

www.arnottinc.com

100 Sea Ray Drive
Merritt Island, FL 32953

Call: 800.251.8993

321.868.3016

Fax: 321.868.3703

Email: techassistance@arnottinc.com

Arnott Europe Business Office:

www.arnotteurope.com

Docterskampstraat 1E/1F, 3
5222 AM 's-Hertogenbosch (NL)

NL Phone: +31 73 7850 580

DE Phone: +31 85 2087 438

UK Phone: +44 203 3186 124

BE Phone: +32 258 846 90

ES Phone: +34 91 901 10 56

FR Phone: +32 78 48 46 93

Email: info@arnotteurope.com

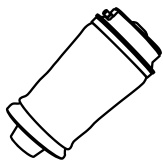

Air Springs

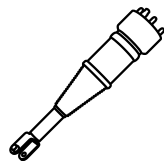

Struts

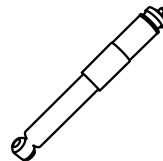

Shocks

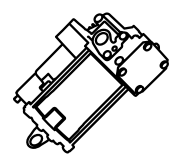

Compressors

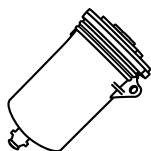

Dryers

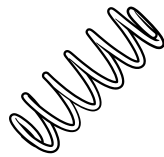

Coil Spring
Conversion Kits

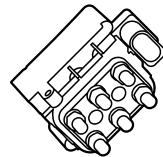

Valve Blocks

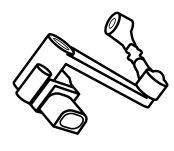

Ride Height
Sensors