

Installation Manual

A-2571 ARNOTT FRONT RIGHT AIR SPRING FOR 2007-2010 AUDI Q7 FOR 2003-2010 PORSCHE CAYENNE FOR 2004-2010 VW TOUAREG



Congratulations on your purchase of an Arnett® air suspension product. We at Arnett Incorporated are proud to offer a high quality product at the industry's most competitive pricing. Thank you for your confidence in us and our product.

Proper installation is essential to experience and appreciate the benefits of this system. Please take a moment to review these installation instructions before you begin to install these components on your vehicle. The removal and installation of air suspension products should only be performed by a fully qualified, ASE Certified, professional.

It is equally important to be aware of all necessary safety measures while installing your new Air Suspension System. This includes proper lifting and immobilizing of the vehicle and isolation of any stored energy to prevent personal injury or property damage.

"Engineered to Ride, Built to Last®"



WARNING: *The air suspension system is under pressure (up to 10 bar, or 150 lbf/in). Verify pressure has been relieved and disconnect power to the air suspension system prior to disassembly. Do not allow dirt or grease to enter the system. Always wear standard hand, ear, and eye protection when servicing the air suspension system.*

Arnett® is committed to the quality of its products. If you have a question or problem with any Arnett product, please contact Arnett by calling [800-251-8993](tel:800-251-8993) during normal business hours or email techassistance@arnottinc.com.

GENERAL INFORMATION:

Reading this manual signifies your agreement to the terms of the general release, waiver of liability, and hold harmless agreement, the full text of which is available at www.arnottinc.com.

- Not to be stored below 5°F (-15°C) or above 122°F (50°C).
- Avoid damage to air lines and cables.
- Removal and installation is only to be performed by fully qualified personnel.
- Use car manufacturer's diagnostic software.

CAUTION: Damage to the vehicle and air suspension system can be incurred if work is carried out in a manner other than specified in the instructions or in a different sequence.



To avoid the possibility of short circuits while working with electric components consult your owner's manual on how to disconnect your battery.



Consult your vehicle owner's manual, service manual, or car dealer for the correct jacking points on your vehicle and for additional care, safety and maintenance instructions. Under no circumstances should any work be completed underneath the vehicle if it is not adequately supported, as serious injuries and death can occur.

AIR STRUT REMOVAL

1. SET STEERING TO STRAIGHT AHEAD.
2. RAISE VEHICLE.
3. REMOVE FRONT WHEEL.
4. REMOVE AIR LINE FITTING FROM THE AIR VALVE. REMOVE THE AIR LINE FITTING FROM THE AIR LINE AND DISCARD. (FIGURE 10-1)



FIGURE 10-1

5. REMOVE THE LOWER SHOCK-MOUNTING NUT AND BOLT. (FIGURES 10-2, 10-3)



FIGURE 10-2

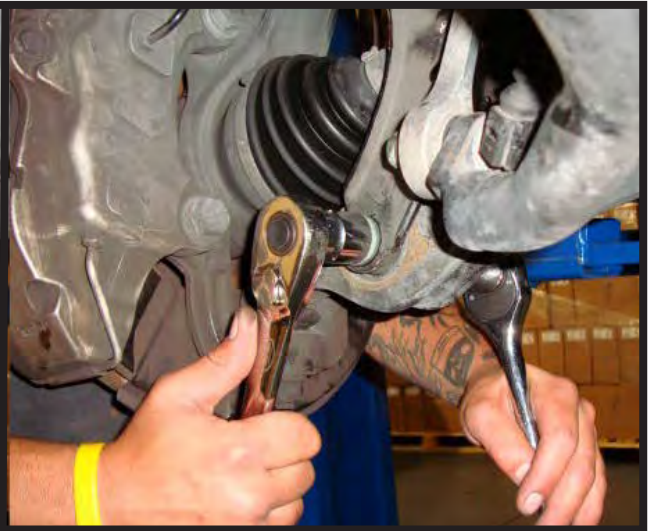

FIGURE 10-3

6. REMOVE THE BALL JOINT NUT FROM THE SPINDLE ASSEMBLY, AND SEPARATE. (FIGURES 10-4, 10-5)



FIGURE 10-4

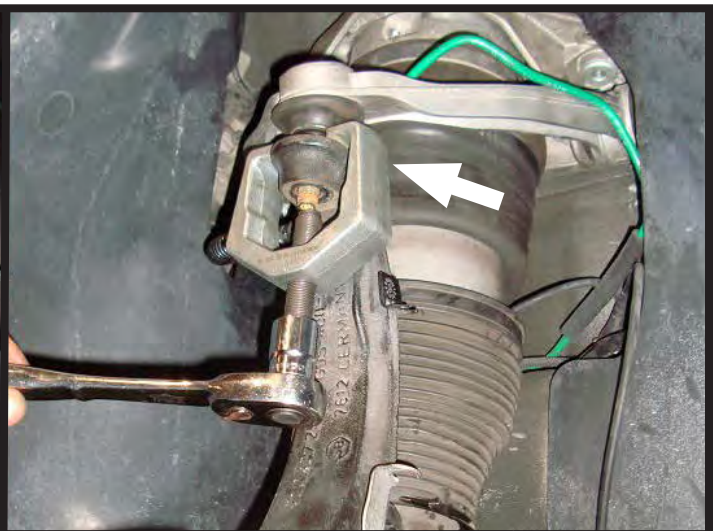

FIGURE 10-5

7. REMOVE THE SWAY BAR END LINK TO SHOCK MOUNTING BOLT. (FIGURE 10-6)



FIGURE 10-6

8. DISCONNECT THE RIDE HEIGHT SENSOR CONNECTOR. (FIGURE 10-7)



FIGURE 10-7

9. LIFT HOOD AND REMOVE THE THREE (3) MOUNTING BOLTS THAT SECURE THE AIR STRUT'S UPPER MOUNT. REMOVE PLASTIC COVER TO GAIN ACCESS TO THE THIRD BOLT. (FIGURE 10-8)

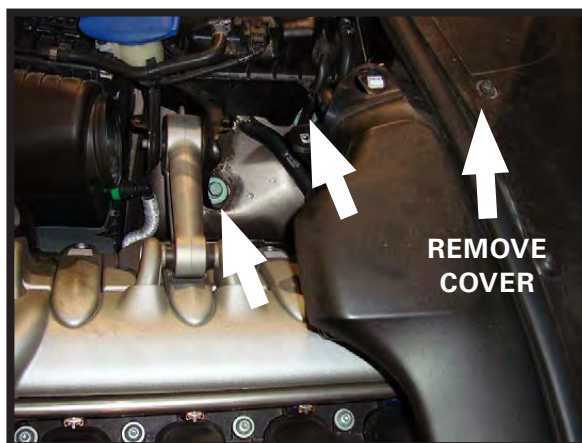

FIGURE 10-8

10. REMOVE STRUT ASSEMBLY FROM THE VEHICLE. (FIGURE 10-9)



FIGURE 10-9

AIR SPRING REMOVAL



Air spring may be under pressure. Slowly remove the air valve to deflate.

1. REMOVE AND DISCARD THE FOUR BOLTS SECURING THE AIR SPRING TO THE AIR SPRING UPPER MOUNT. (FIGURE 20-1)

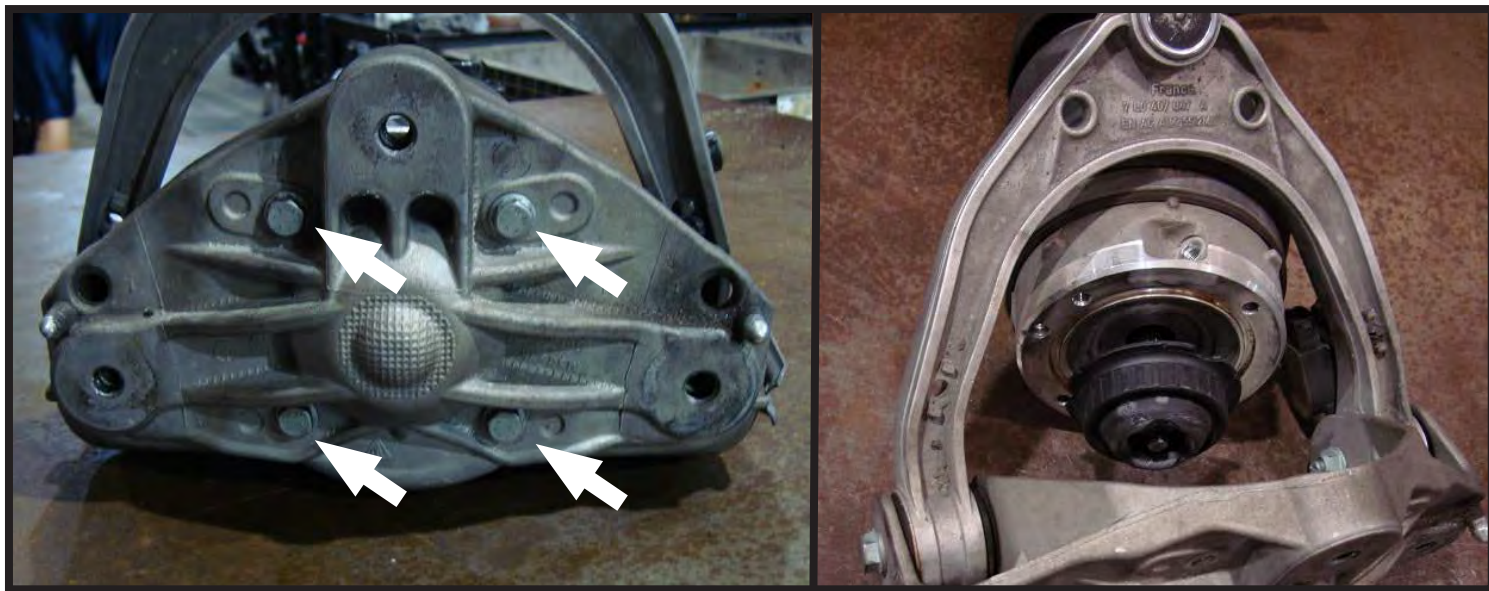

FIGURE 20-1

2. REMOVE THE TOP SHOCK ROD NUT FROM THE AIR SPRING. REMOVE AND DISCARD THE OLD RUBBER ROD END MOUNT AND THE O-RING. (FIGURE 20-2)

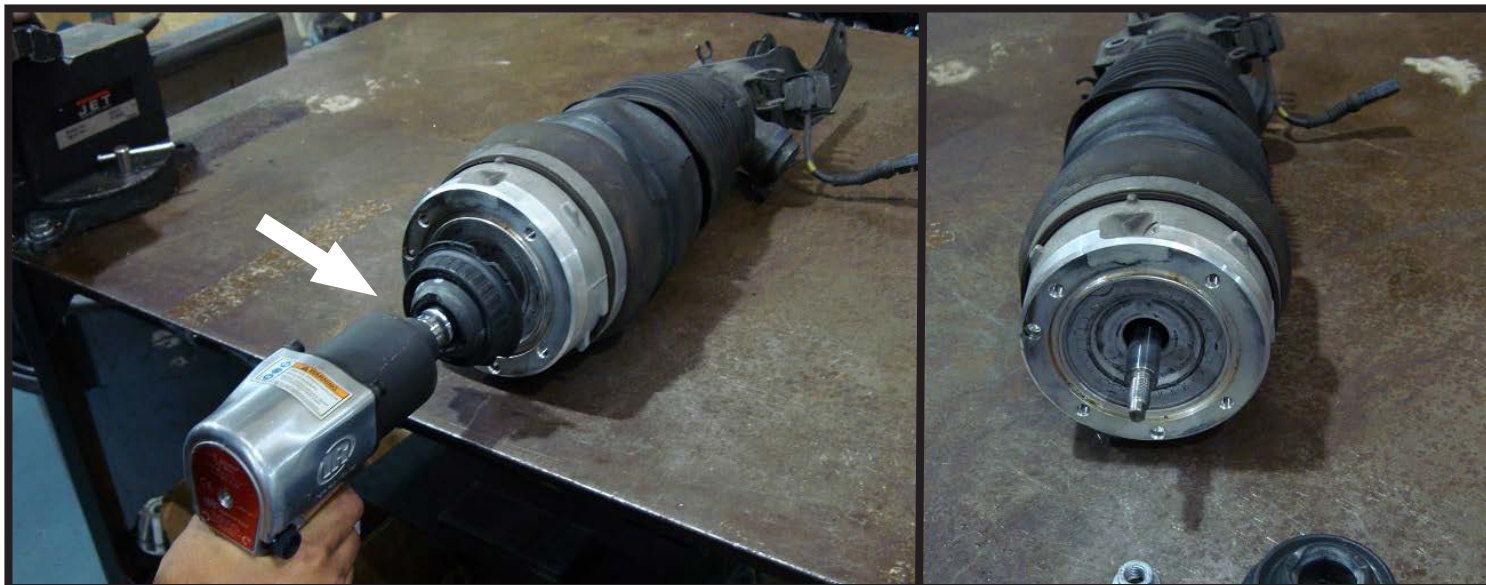

FIGURE 20-2

3. REMOVE THE BOTTOM OF THE DUST BOOT FROM THE SHOCK. (FIGURE 20-3)



FIGURE 20-3

4. REMOVE AIR SPRING ASSEMBLY FROM THE SHOCK. REMOVE THE LOWER SHOCK O-RING AND DISCARD. (FIGURE 20-4)

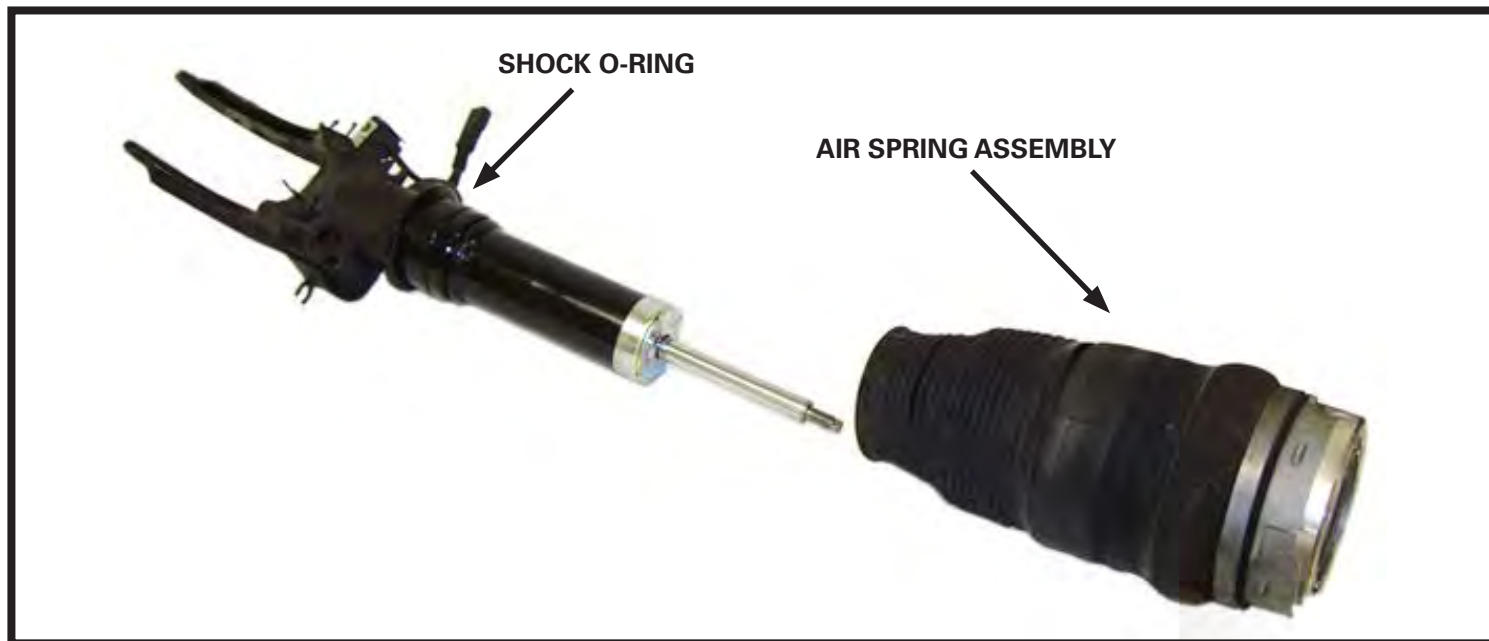

FIGURE 20-4

AIR SPRING INSTALLATION



Tighten all nuts and bolts to manufacturer's specifications during the installation process.

1. INSTALL NEW SHOCK O-RING, APPLY LUBRICATION TO THE O-RING. USE CAUTION WHEN INSTALLING O-RING - IF DAMAGED, THE AIR SPRING WILL NOT HOLD PRESSURE. (FIGURE 30-1)



FIGURE 30-1

2. INSTALL THE NEW AIR SPRING ONTO THE SHOCK. (FIGURE 30-2)



FIGURE 30-2

3. INSTALL THE NEW O-RING AND RUBBER ROD END MOUNT AND NUT ONTO THE SHOCK, TIGHTEN TO MANUFACTURER'S SPECIFICATION. (FIGURE 30-3)



FIGURE 30-3

4. ALIGN THE AIR INLET WITH THE SHOCK FORKS (FIGURE 30-4).

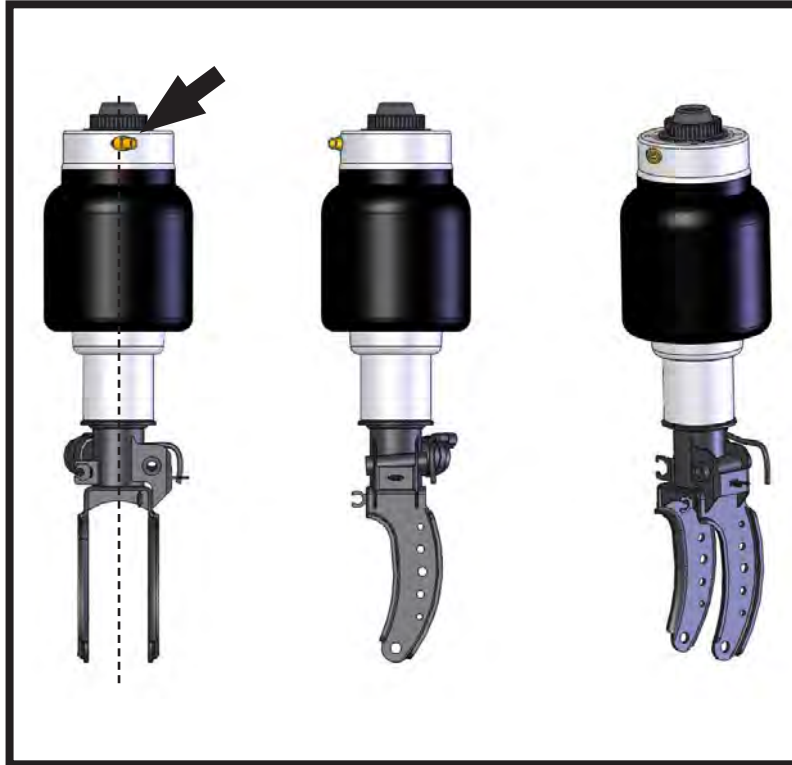

FIGURE 30-4

5. INSTALL THE NEW FOUR BOLTS SECURING THE AIR SPRING TO THE UPPER MOUNT. (FIGURE 30-5)



FIGURE 30-5

AIR STRUT INSTALLATION



Tighten all nuts and bolts to manufacturer's specifications during the installation process.



Do not remove the air fitting from the air spring. Doing so may cause damage and/or void warranty. Remove the white shipping pin from the new air fitting and insert the air line until fully seated.

1. INSTALLATION IS IN REVERSE ORDER OF AIR STRUT REMOVAL.